

# CPS 616 Technologies of the Information Age Introductory Material

<http://www.npac.syr.edu/users/gcf/cps616master99>

Instructor: Nancy McCracken

teamed with Geoffrey Fox and Wojtek Furmanski and many  
talented NPAC students



Syracuse University  
NPAC  
111 College Place  
Syracuse NY 13244 4100  
Phone: 3154432163

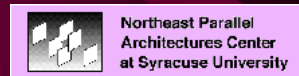

1/19/99 cps616master99 <http://www.npac.syr.edu> [gcf@npac.syr.edu](mailto:gcf@npac.syr.edu)

1

## Abstract of CPS 616-99 Introductory/Administrative Set

- This Foilset contains introductory material on **CPS616** course for spring 1999
- Some Aspects of **Course Logistics** -- all students must go to web sites for complete discussion of this
  - <http://www.npac.syr.edu/projects/cps616spring99/>
  - <http://www.npac.syr.edu/projects/jsuspring99/>
- Overview of Field and Material covered and relation to other courses **CPS606 CPS640 CPS714** and **Syracuse University CIS PhD Qualifying exams**
- Summary of Base Pragmatic **Object Web** and **Relevant Technologies**
- This field is also called **Internetics**

1/19/99 cps616master99 <http://www.npac.syr.edu> [gcf@npac.syr.edu](mailto:gcf@npac.syr.edu)

2

## Overview of CPS Web/Information Technology Courses - I

- **CPS606** Taught last semester is basic **Java** and **Perl** (CGIScripts) and introduction to RMI (Remote Method Invocation)
- **CPS616** is critical leading edge distributed object and web software system and application building technologies including **JavaScript**, **Advanced Java Capabilities**, **Web-linked Databases**, **Security**, **Object Web**.
- **CPS616** contains **core software technologies** needed to build **world wide distributed systems** -- this is the **key challenge** today in **computer science**
- **CPS714** is new and specialized topics in the same area as **CPS616** and is set up as a mix of lectures and a project course
- **CPS640** is **MultiMedia** and **Network Systems** including **digital video** -- it is the hardware and network technologies needed for **world wide distributed systems**
- **CPS690** are introductory research projects with Geoffrey Fox and NPAC staff

1/19/99 cps616master99 <http://www.npac.syr.edu> gcf@npac.syr.edu

3

## Overview of CPS Web/Information Technology Courses - II

- Courses **CPS606**                      **616**                      **714**  
    <--- HTML Java Web Technologies Web Systems <--
- Material changes with **time**(<-->) so that as new technologies added in **CPS714**, older and better understood ones are moved into **CPS616** which itself hands technologies to **CPS606**!
  - **Example: RMI (Java Remote Method Invocation)** was taught in **CPS606** last semester for first time. Previously it was in **CPS616**. **VRML** has been de-emphasized as it appears to decline in interest
  - **Security and object/component technologies** (such as **Javabeans**) were covered in **CPS714** last time and will be part of **CPS616** this spring
  - **Web Computing and Collaboration** will stay in **CPS714**

1/19/99 cps616master99 <http://www.npac.syr.edu> gcf@npac.syr.edu

4

## Overall Course Details

- There are two sections of course:
  - 1) Main Syracuse University Offering: 4 --> 5.20pm Tuesday Thursday
  - 2) Internet Section (Access via TangoInteractive or in room 3-201 CST): 5-> 6.20pm (Eastern Time) Monday Wednesday
  - All Students MUST read introductory material at Web Sites
  - 1) Syracuse Course: <http://www.npac.syr.edu/projects/cps616spring99/>
  - 2) Internet Section of Course: <http://www.npac.syr.edu/projects/jsuspring99>
  - Instructor: Nancy McCracken [njm@npac.syr.edu](mailto:njm@npac.syr.edu) X4687, Room 3-234
  - Reserve Instructor: Geoffrey Fox [gcf@npac.syr.edu](mailto:gcf@npac.syr.edu), Phone X2163, Room 3-131 CST
  - There are no special books as we are covering so much material and much is on the Web.
    - We are writing a new book “Building Distributed Systems on the Pragmatic Object Web” which will be made available to students at <http://osprey6.npac.syr.edu:8000>
    - Other books will be recommended in various parts of course
    - <http://www.npac.syr.edu/projects/tutorials> has background material
- 1/19/99 cps616master99 <http://www.npac.syr.edu> [gcf@npac.syr.edu](mailto:gcf@npac.syr.edu) 5

## Some Course Prerequisites

- We will assume Basic Web Browsing and HTML expertise and Java at the level of CPS606
  - Permission of Instructor is needed if you have not taken CPS606
- You should be familiar with either PC or UNIX environment and program in at least one real language including Java
  - Perl could be useful but not essential -- we will not teach Perl
- We will not assume any database or CORBA knowledge and will review basic material such as SQL
- NPAC provides servers for you to access Oracle databases and other needed core resources
- You need a UNIX workstation or a PC running Windows (95,98 or NT)

## Some Pluses and Minuses

- **CPS616** material underlies all major new software systems built by modern companies and so you can get ahead by exploiting **NPAC**'s unusually deep knowledge of it as we are engaged in **many significant distributed systems projects**
  - Several successful students from these classes end with either good jobs in Universities, Industry and/or research assistantships with NPAC
  - NPAC emphasizes “serious deliverables” not long term research
- Geoffrey Fox leads NPAC but **is out of town** some 40% of the time starting the end of January. Thus he misses many classes This is plus and minus respectively of being at leading edge .....
- **If you register for class, you accept this “feature”**

1/19/99 cps616master99 <http://www.npac.syr.edu> gcf@npac.syr.edu

7

## Components of a Basic Web System

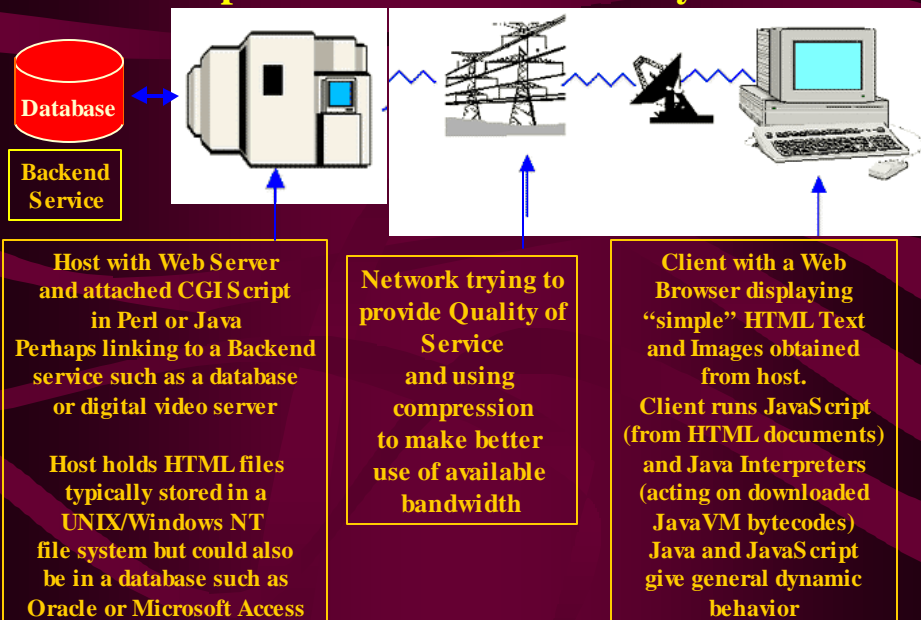

1/19/99 cps616master99 <http://www.npac.syr.edu> gcf@npac.syr.edu

8

## Where to learn What you Want!

- **CPS606:** HTML, Java and CGI Scripts with PERL
- **CPS640:** Network Services, Multimedia Systems including Server and Client Digital Video
- **CPS616:** Web-linked Databases (JDBC to Cold Fusion), JavaScript, Javabeans, dynamic HTML, XML, Java Web Servers, Servlets, RMI, Java IDL, CORBA, COM, ActiveX, Security, JDK1.2, and some mention of Lotus Notes, VRML 2.0, Java2D and Java3D
- **CPS714:** Collaborative and Computing Technologies and whatever is on leading edge

## Basic (CPS 606) Structure of World Wide Web

- **Browsers** have SAME interface on ALL Computers
- **CGI Programs** were originally usually written in PERL but can be essentially any Process and so do simulation, database access (this is **JDBC**), advanced document processing etc. **Java** (servlets) is of growing importance in Server Code

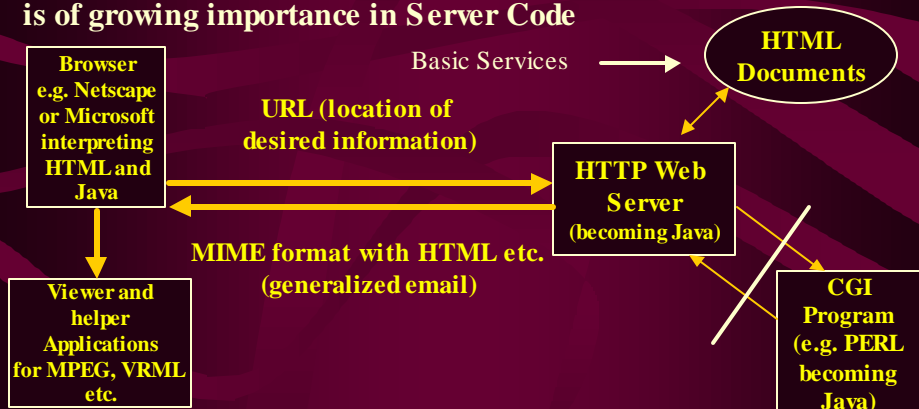

## The 1997 Web Client Server Model

- There are evolving/confusing/overlapping capabilities ...

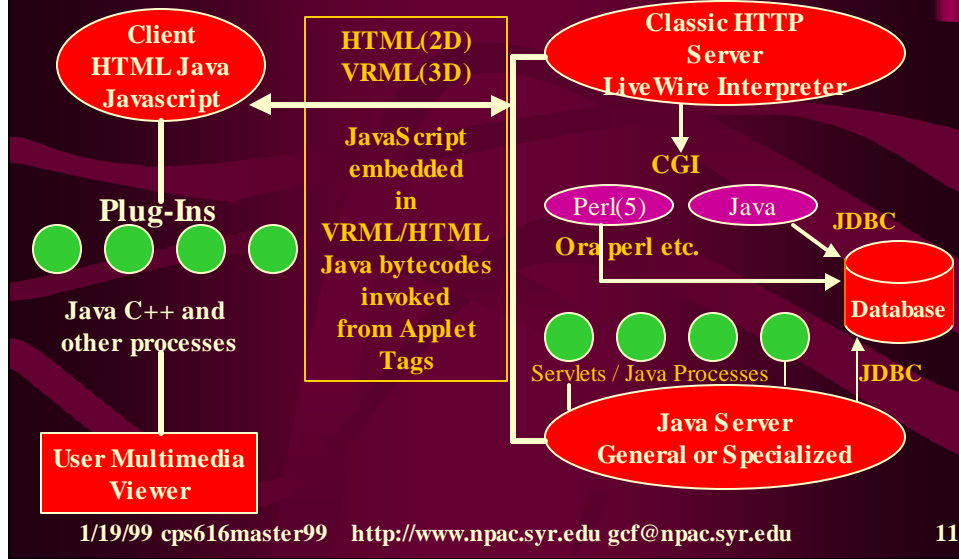

## Architecture of Web Software

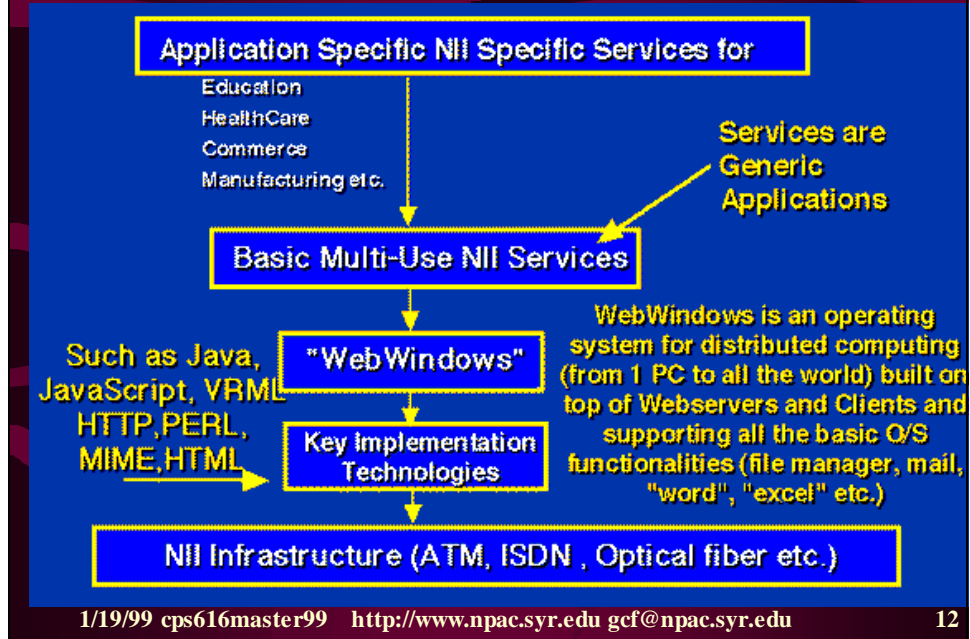



## The 1998 3(Multi)-Tier Information System Architecture

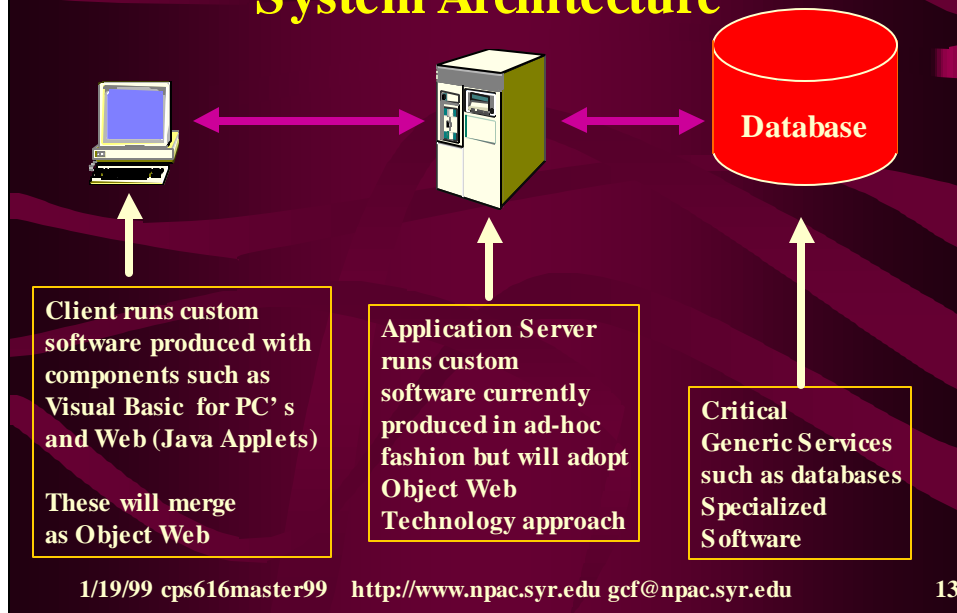

## Pragmatic Object Web Technology Model - I

- **Basic Vision:** The current incoherent but highly creative Web will merge with **distributed object technology** in a multi-tier client-server-service architecture with Java based combined Web-ORB's
- Need to abstract entities (Web Pages, database entries, simulations) and services as **objects with methods(interfaces)**
  - CORBA .. XML is "just" CGI done right
- COM(Microsoft) and CORBA(world) are competing cross platform and language object technologies
  - Every Netscape4 browser has a Visigenic ORB built in
- Javabeans plus RMI and JINI is 100% pure Java distributed object technology
- W3C says you should use XML which defines a better IDL and perhaps an **object model** -- certainly does for **documents**
- How do we do this while technology is still changing rapidly!

## Multi-Tier Client Server Service

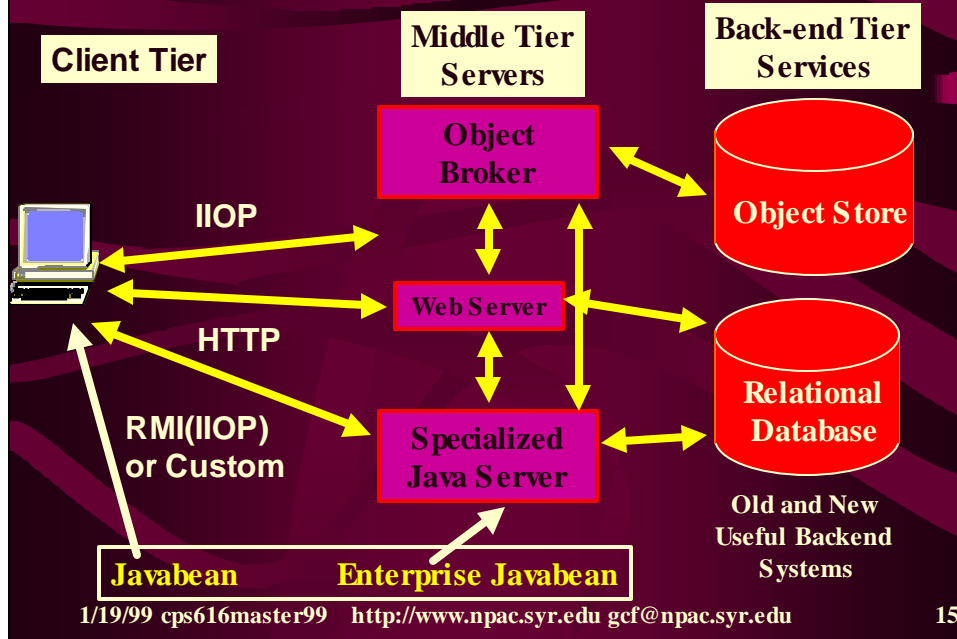

## Pragmatic Object Web Technology Model - II

- Need to use mix of approaches -- choosing what is **good** and what **will last**
- For example develop **Web-based databases with Java objects** using standard JDBC (Java Database Connectivity) interfaces
  - Oracle DB2 Informix Sybase, Lotus Notes, Object database confusion becomes an issue of **performance/robustness NOT functionality**
- Even better use (**Enterprise**) **Javabeens** which are Java's (**middle tier**) or **client componentware** offering visual interfaces, containers (here they are consistent with CORBA standard) and standard software engineering interfacing rules
  - e.g. **Java Blend** is built on top of JDBC to use enterprise Javabeens to store **Java Objects** in relational databases
- Use **CORBA** to wrap existing applications
- Note **Middle tier** insulates client from backend -- can use one object model for user level and different one for backend
  - specialized **object databases** getting “overwhelmed” by multi-tier approach with Oracle etc. traditional backends



## Specifying Server Side Objects

- Documents -- URL
- "General Programs including database invocations"
  - Old style Web -- CGI
  - New Style Web -- XML makes server side objects look like applets as far as invocation goes
  - CORBA and COM -- special "interface definition language" (IDL) defines invocation in C++ like syntax
  - RMI uses Java language as IDL language

## Two Database Web Linkages

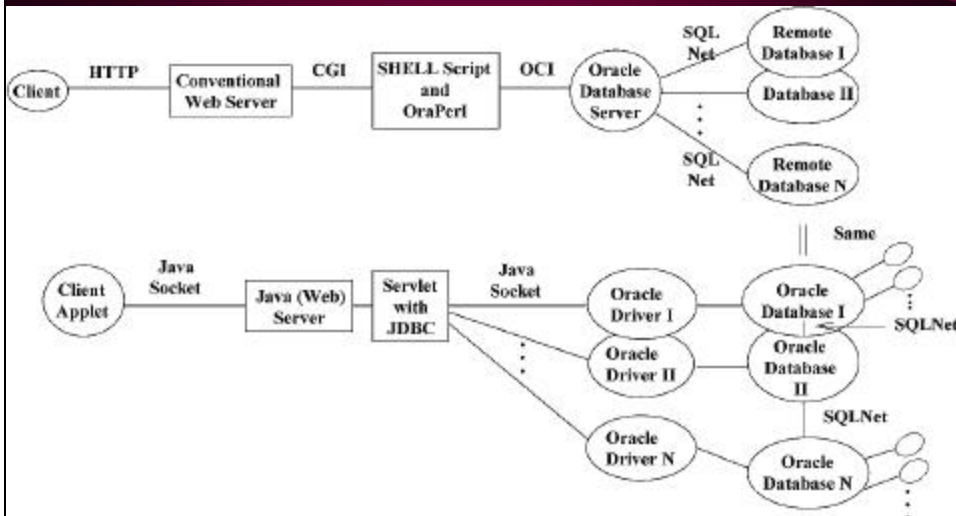

## Two More 3 Tier Web Database Links

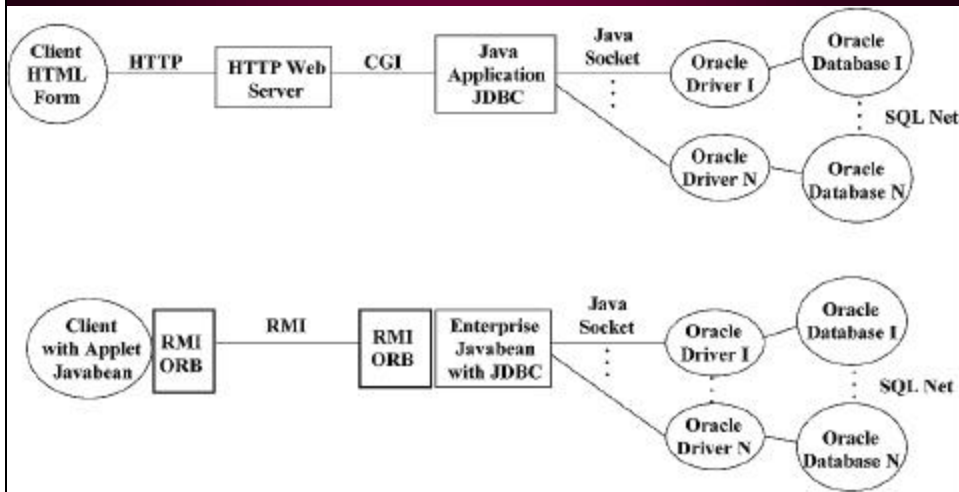

## 2 Tier and CORBA Models

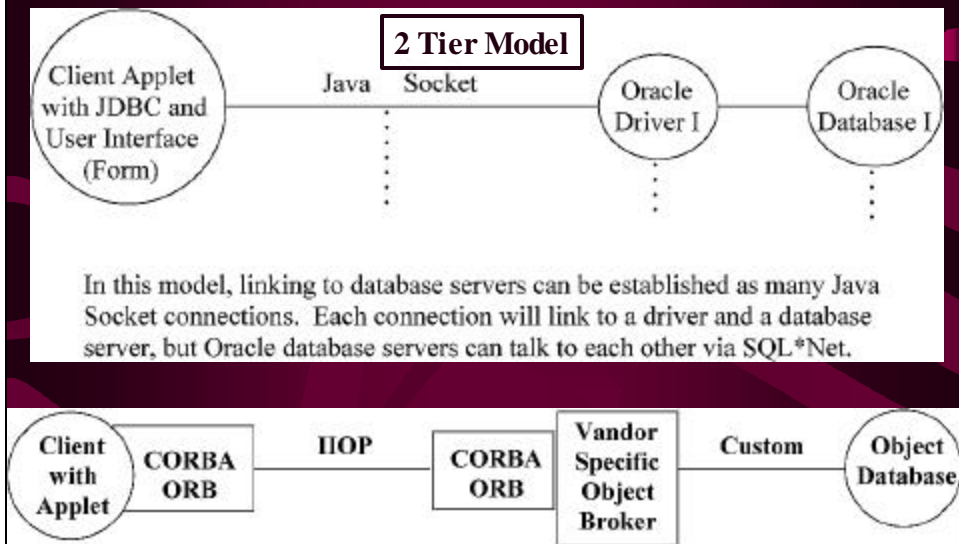

In this model, linking to database servers can be established as many Java Socket connections. Each connection will link to a driver and a database server, but Oracle database servers can talk to each other via SQL\*Net.

## Comparison of 2 3 and 4 Tier Models

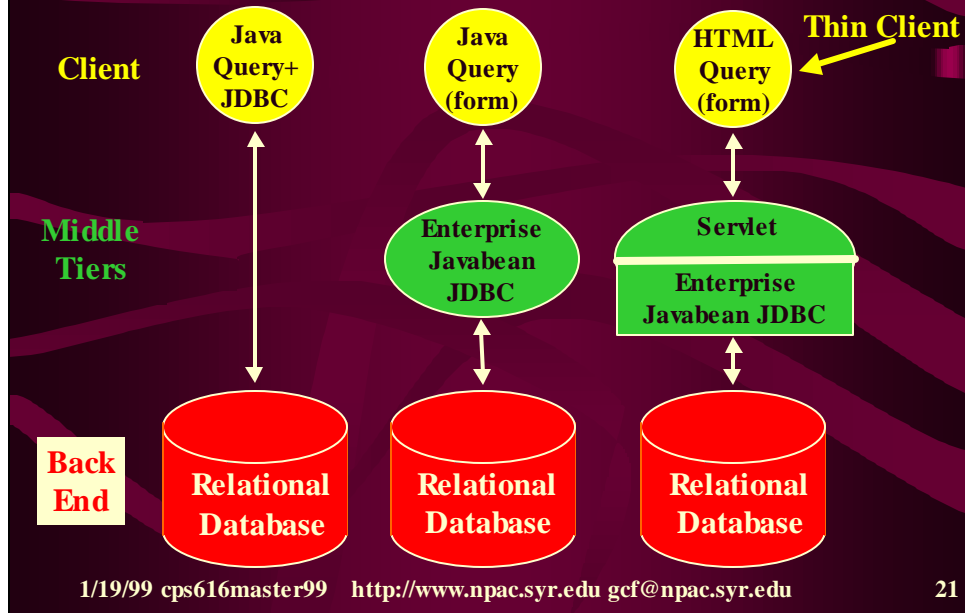

## Two ways of Implementing Data Objects

- Old way: Use an Object Database



- Current Approach: Use a Relational Database and business logic in EJB

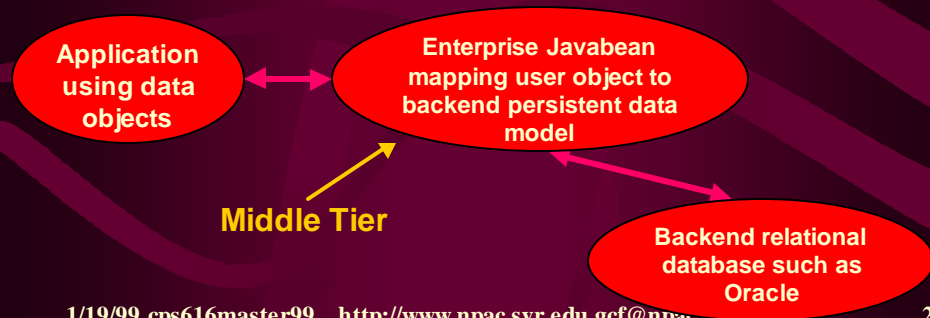

# Today's Pragmatic Object Web: The Confusing Multi-Technology Real World Middleware Server Layer

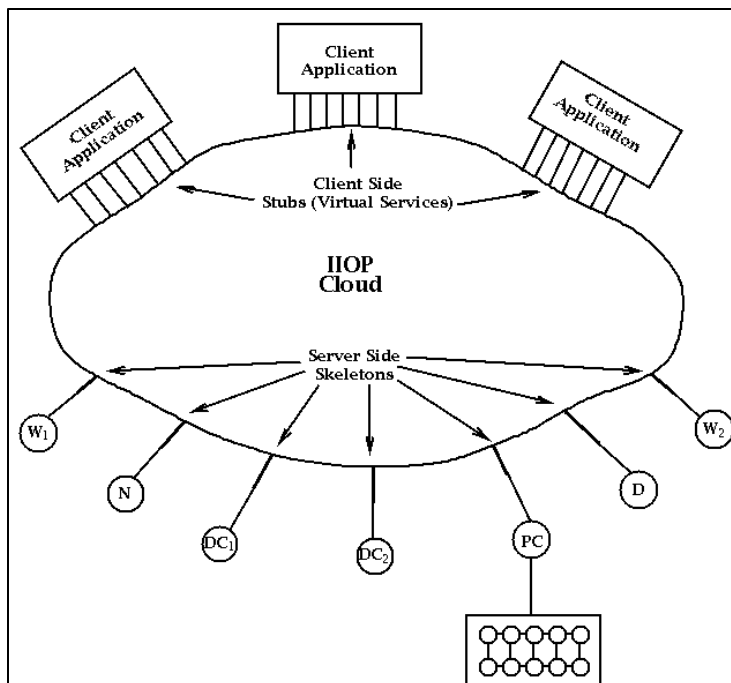
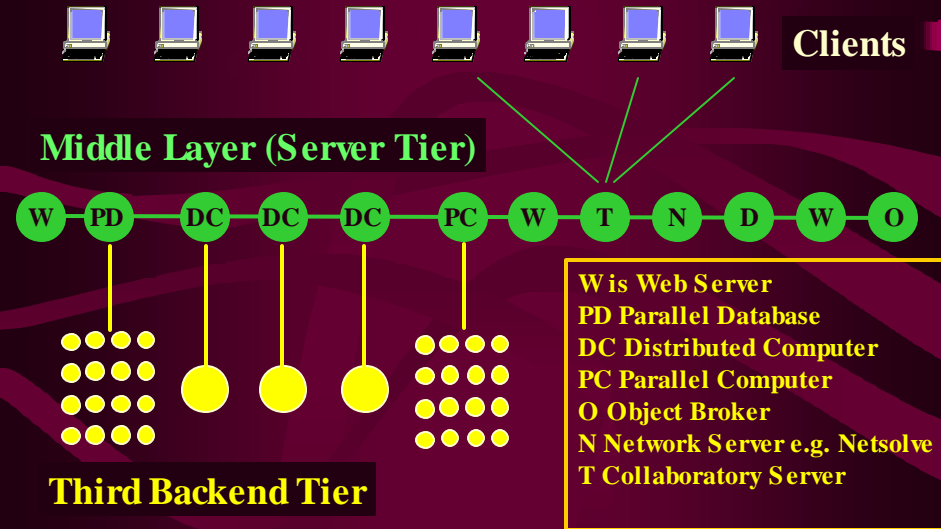

Today's Complex World will evolve to something like the pure CORBA Architecture for a distributed Information System (There are similar COM and Javabean /RMI Versions)

# Emerging Object Web Multi-Server Model

Clients and their servers

Middle Tier Custom Servers

Back End Servers and their services

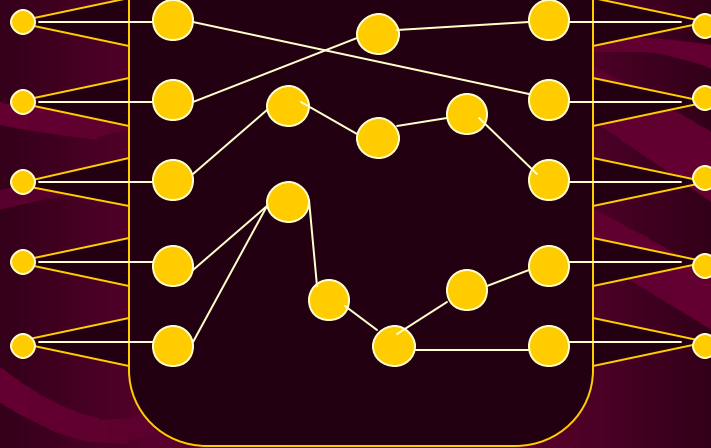

# Multi-Server Web Computing System

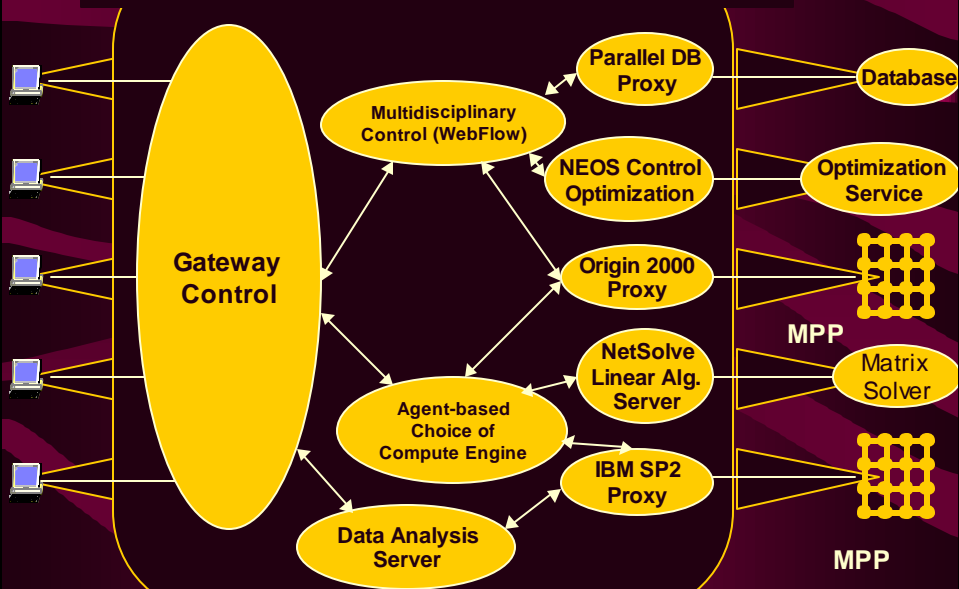

## NPAC Concept: Summary of Pragmatic Object Web

- **3-(or more)-tier architecture** - Web browser front-ends, legacy (e.g. databases, HPC modules) backends; fat middleware
- Use as appropriate the alternative / competing **Middleware** models:
  - **Java RMI+ EJB (Enterprise Javabean)** - single language solution by Sun
  - **CORBA** - all languages solution by OMG
  - **COM** - multi-language solution by Microsoft
  - **WOM/XML** - emergent solution by the Web Consortium
- Each model has different tradeoffs (most **elegant, powerful, fastest, simplest**)
- **POW** attempts to **integrate** various models and services in terms of **multi-protocol middleware servers (JWORB)**
  - Note **Java** is often the **best language** to build **middleware** whether this is Java or some other distributed object model
  - Most **commercial Java** activity is on **Server not Client**

## Web Technologies in a Nutshell -- Java

- **Java** -- Objected Oriented version of C/C++ supporting Interactive Distributed Computing. Original Web architecture (e.g. CGI) was server-side. Java allows design and Implementation of **balanced Client Server** Applications
- Java likely to be a dominant software engineering and Scientific Computing language -- see <http://www.javagrande.org>
- This course will not discuss Java as a language but rather as a system building tool
- Java will probably be preferred language for development of next generation general or custom Web servers and clients
  - NPAC's **TANGO collaboratory** built around a custom Java Tier-2 server
- Java can build client side **customized GUI's** and graphics/image processing but JavaScript and DHTML competes here and **MOST Industry use of Java is in middle tier**
- New **Java 1.1/1.2** have several enhancements including very many specialized API's
- **Javabeans** are (visual) component model for Java applications

## Web Technologies in a Nutshell - JavaScript

- **JavaScript** -- only superficially related to Java and was called **LiveScript** -- is Netscape's (somewhat supported by Microsoft) fully interpreted Client side extension of HTML. This is a good Client Window integration /customization technology where flexibility more important than performance
- i.e. use JavaScript for Rapid Prototyping of Complex User Interfaces
  - First examples use JavaScript together with frames ( HTML extension) for **interactive multi-window technologies**
  - JavaScript is roughly equivalent to "**Abstract Windowing Toolkit/ Layout Manager**" in Java but applied to Browser Frames and not Java windows
  - JavaScript cannot build complex filters or simulations as slow
  - But **JavaScript with dynamic HTML** is powerful client technology which is often easier and **faster** than Java -- it is faster as invokes optimized browser functions
  - both Internet Explorer 4 and Netscape have excellent JavaScript support
- Server side version of JavaScript called **LiveWire** runs on Netscape Servers -- **unsuccessful**
- Expect **client** side use of **JavaScript** to grow in **importance**

1/19/99 cps616master99 <http://www.npac.syr.edu> gcf@npac.syr.edu

29

## Web Technologies in a Nutshell - DHTML

- There is an emerging **DOM** or **Document Object Model** which will be uniform model used by W3C, Netscape, Microsoft
  - It allow you to address **individual components** of a page e.g. text box, image or collections thereof as separate entities
  - **DOM** is quite close to **IE 4.0** conventions
- **Cascading Style Sheets** allow one more powerful ways of assigning properties (such as color fonts etc.) to these components using either name(id) or type (<h2> tag etc.)
- **DHTML** or **dynamic HTML** allows one to address the components of document and change on the fly (without reloading page) the properties of these components
  - This includes not only natural style properties but also position, size and "**visibility**"
  - DHTML currently **handicapped** by **major differences** between IE4 and Netscape 4 -- functionalities are similar but syntax very different
  - **JavaScript** combined with DHTML allows animations, graphs and replacement of just parts of text

1/19/99 cps616master99 <http://www.npac.syr.edu> gcf@npac.syr.edu

30



## Web Technologies in a Nutshell - XML

- **HTML** is powerful but does not separate display and form (structure of document component as an object)
- **XML** is a generalization of HTML which allows definition of arbitrary tags
- e.g. `<student name="Jane Doe" class="CPS 616" grade="..." >Working Hard</student>` is more elegant way of capturing information in a reliable fashion than HTML
- `<h2>Students</h2>`  
`<ul><li>Jane Doe: Working Hard</li><ul>`  
    `<li>Class: CPS 616</li>`  
    `<li>Grade: ...</li> .... </ul>`  
`</ul>` with a PERL program to extract data
- **XML** allows powerful way of defining **dynamic Ascii databases** useful for "modest size data" such as people, document citations etc.
- **XML parsers** map XML tags into HTML for display
- **XML** can also be used to define **extensions to HTML** such as special tags for mathematics or chemistry or .....
- **XML** defines syntax for "**serializing**" Web objects and transmitting between clients and servers

1/19/99 cps616master99 <http://www.npac.syr.edu> [gcf@npac.syr.edu](mailto:gcf@npac.syr.edu)

31

## Web Technologies in a Nutshell - PERL

- **PERL** is a relatively old technology which is being overtaken by Java tidal wave.
- Still PERL has significantly better Systems and Document handling capability than Java
  - Very good for UNIX as much easier than Shell for system scripts -- PC versions exist but not so well integrated into O/S
  - Wonderful regular expression handling
- PERL is traditional but probably **not best choice for server CGI** extensions and development of filters
- -- except for simpler cases involving text documents
- PERL5 is object oriented but much less elegant (in my opinion) than Java
  - PERL5 has very useful multidimensional associative and regular arrays
- PERL has well understood links to databases such as **Oracle oraperl**

1/19/99 cps616master99 <http://www.npac.syr.edu> [gcf@npac.syr.edu](mailto:gcf@npac.syr.edu)

32

## Web Technologies in a Nutshell - Databases

- The Web provides a convenient integration environment for "mature" technologies migrating from existing computer environments.
- Relational databases are a good example where it is now straightforward in Microsoft Access, Oracle, DB2, Informix, Sybase etc. to provide a Web Interface which can be used for data (mail, curricula material etc.) with Java/JavaScript/Forms based Interfaces
- Object databases such as Illustra also interfaced to Web
- Systems such as **Cold Fusion** provide convenient high level interfaces to Web-linked databases
- Several excellent Java to Database packages becoming available with the **JDBC** standard based on ODBC -- more powerful but lower level than systems like Cold Fusion
- CORBA will have good Web and Java Interfaces and we will discuss integration of Web CORBA and database technologies
  - CORBA views a database as a **managed persistent object**

## Web Technologies in a Nutshell - VRML

- **VRML** plays same role to 3D worlds that HTML does to documents
- **VRML 1.0** has been widely available and specifies static 3D scenes through which you can navigate. Already provides universal visualization environment and we have examples of use In Geographical Information Systems
  - Note can embed clickable URL's as with ImageMaps which can be used to annotate images to provide interactive resources
- **VRML 2.0** is now the standard with critical enhancements so that individual elements of 3D world are dynamic and can be programmed
  - It is designed to support full interactivity (televirtuality) with texture mapped video, avatars etc.
  - VRML 2.0 could require huge computing resources whether used as the virtual car-dealership / interactivity gaming or more academic uses such as collaboration between teachers and students in 3D virtual classroom
- **Bandwidth and computing** needs of VRML are handicapping acceptance and appears that **VRML will NOT "make it"** -- replacement unclear
  - Microsoft **ChromeEffects** (XML based) and
  - **Java3D** address some but not all VRML applications